

user manual

CP-500

warewash dispenser

(This page was intentionally left blank.)

index

1.00	overview	page
1.01	Package Contents	4
1.02	Operation	4
1.03	General Specifications	4
1.04	Model Numbers and Features	5
2.00	installation	
2.01	Site Survey & Installation Requirements	6
2.02	Wall Mount	6
2.03	Mechanical Installation	7
2.04	Electrical Installation and Programming	8
3.00	operation	
3.01	Description of Controls	13
4.00	service parts	13
5.00	maintenance	
5.01	Maintenance (Required)	14
5.02	Pump Tube Replacement	14
6.00	troubleshooting	
6.01	Troubleshooting Table	15
7.00	specifications	
7.01	Specifications	15
8.00	warranty	
8.01	Limited Warranty	16
8.02	Limitation of Liability	16

1.00 overview

Safety Precautions



WARNING Please read precautions thoroughly before operation. Meet all applicable local codes and regulations.

THANK YOU FOR YOUR INTEREST IN OUR PRODUCTS

Please use this equipment carefully and observe all warnings and cautions.

WEAR protective clothing and eyewear when dispensing chemicals or other materials or when working in the vicinity of all chemicals, filling or emptying equipment, or changing metering tips.

ALWAYS observe safety and handling instructions of the chemical manufacturer.
direct discharge away from you or other persons or into approved containers.
dispense cleaners and chemicals in accordance with manufacturer's instructions. Exercise CAUTION when maintaining your equipment.
reassemble equipment according to instruction procedures. Be sure all components are firmly screwed or latched into position.

KEEP equipment clean to maintain proper operation.

WARNING The CP500 is a double-insulated product marked as . In a double-insulated product, two systems of insulation are provided instead of grounding. No grounding method is provided on a double-insulated product nor should a method of grounding be added. Servicing a double-insulated product requires extreme care and knowledge of the system and should be done only by qualified service personnel. Replacement parts for a double-insulated product must be identical to the parts they replace.

1.01 Package Contents

CP-500 Warewash Dispenser (part number varies by model)

- CP-500 Dispenser (Part number varies by model)
- Quick Start Guide (P/N HYD10099215)
- Accessory Kit: Mounting bracket, fittings, hardware, and pickup tubing (Part number varies by model)
- Pump Squeeze Tube (not installed)
 - Detergent models use Santoprene® tubes as standard
 - Rinse models use silicone tubes as standard
 - (Part number varies by model)



1.02 Operation

The CP-500 is a globally versatile, single product dispenser used to supply detergents or rinse aid into automatic dish machines. Designed with simplicity in mind, the unit can be installed in minutes and requires no programming; all settings can be configured using potentiometers that control the time or speed of dosing (depending on the model). The unit has the reliability and accuracy you expect from Hydro Systems Co. at an economic price point.

NOTE! The CP-500 is intended for use in industrial applications. It is not suitable for domestic use, and it must not be used outside of its intended use. The product must only be used for commercial dish washing operations. The manufacturer waives any responsibility arising from incorrect usage or transportation.

1.03 General Specifications

Category	Specification
Electrical	90 to 260 VAC at 50/60Hz
Chemical Temperature Rating	Intake chemicals should be at room temperature
Regulatory Approvals (CE)	89/336/CEE 73/23/CEE Regarding "Electromagnetic Compatibility" and the subsequent modifications to 92/31/CEE, 93/68/CEE, 93/97/CEE Regarding "Low Voltages", and the subsequent modifications to 93/68/CEE, 2002/95/CE, 2002/96/CE, 2003/108/CE "RoHs and WEEE Directive"
Regulatory Approvals (UL / CSA)	UL 778:ed6-2016 CSA C22.2 No.108:14 Standard for Motor-Operated Water Pumps Liquid Pumps
Cabinet Material	Front: Polypropylene - Rear: Polypropylene
Environmental	Pollution: Degree 2, Temperature: 50° to 104° F (10° to 40° C), Maximum Humidity: 95% Relative
Dimensions	5.0 in (128 mm) High x 3.6 in (91 mm) Wide x 4.1 in (104 mm) Depth

1.00 overview (continued)

1.04 Model Numbers and Features

Pump Build Options:

Pump Type: D = Detergent
R = Rinse

Adjustment Combo: 1T = Time
1TT = Time Time
2TT = 2 Solenoids Time Time
1S = Speed
1SS = Speed Speed
1ST = Rinse by Time and Speed

Flow Rate: 017 = 17 ml per minute
067 = 67 ml per minute
100 = 100 ml per minute

Pressure: 1 = 1 bar (14.5 psi)
3 = 3 bar (43.5 psi)

Tube Material: SA = Santoprene
SI = Silicon

Level Input: N = None
L = Level Included

Electrical Approvals: CE = CE
UL = UL

Build Example: HYDCP500- R 1S 017 3 SI N UL

Model Builder:	Hydro Prefix	Base Model	Pump Type	Adjustment Combo	Flow Rate	Pressure	Tube Material	Level Input	Electrical Approvals
Popular UL Models (1 Valve Dish Machine)									
HYDCP500-D1TT1001SANUL	HYD	CP500-	D	1TT	100	1	SA	N	UL
HYDCP500-R1ST0173SINUL	HYD	CP500-	R	1ST	017	3	SI	N	UL
Popular UL Models (2 Valve Dish Machine)									
HYDCP500-D2TT1001SANUL	HYD	CP500-	D	2TT	100	1	SA	N	UL
HYDCP500-R1S0173SINUL	HYD	CP500-	R	1S	017	3	SI	N	UL
Popular CE Models (1 Valve Dish Machine)									
HYDCP500-D1TT1001SANCE	HYD	CP500-	D	1TT	100	1	SA	N	CE
HYDCP500-R1ST0173SINCE	HYD	CP500-	R	1ST	017	3	SI	N	CE
Popular CE Models (2 Valve Dish Machine)									
HYDCP500-D2TT1001SANCE	HYD	CP500-	D	2TT	100	1	SA	N	CE
HYDCP500-R1S0173SINCE	HYD	CP500-	R	1S	017	3	SI	N	CE

Wiring Example - Single-Valve Dish Machine

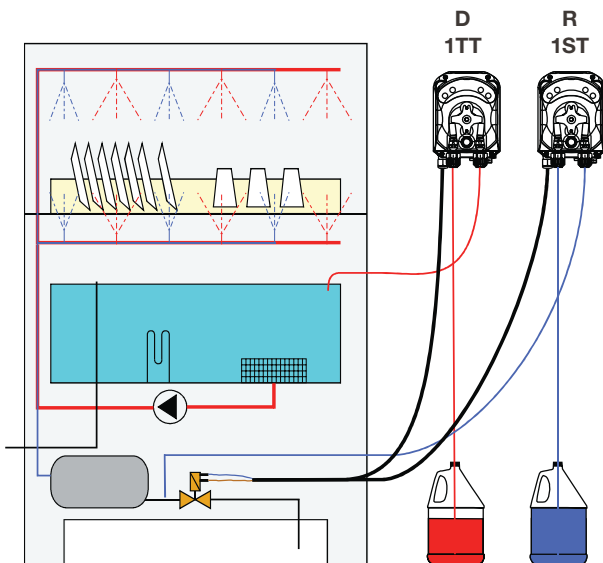

Wiring Example - Two-Valve Dish Machine

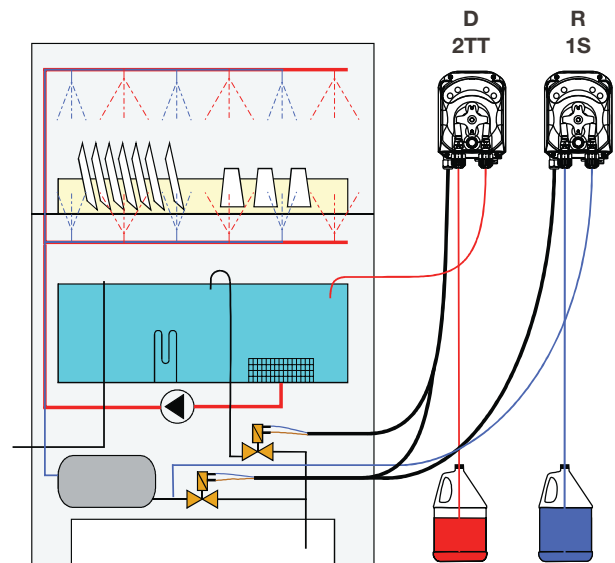

2.00 installation

2.01 Site Survey & Installation Requirements



WARNING! This product is intended to be installed by experienced installers, in accordance with all applicable electrical and plumbing codes.

- Unit must not be installed near areas that suffer excess temperature changes, direct sunlight, frost or moisture of any kind.
- Area must be free of high levels of electrical noise.
- Ensure the unit can be mounted in an accessible position above the height of the required discharge location.
- Unit must be mounted on a suitable wall, that is flat and perpendicular to the floor.
- The unit location should be well lit for any maintenance and free of high levels of dust / air particulates.
- Scheduled maintenance should be carried out on the dispenser at least once per year.

2.02 Wall Mount

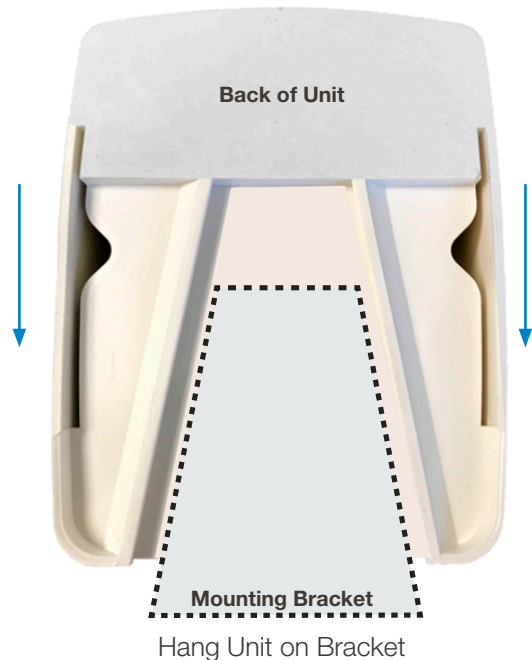
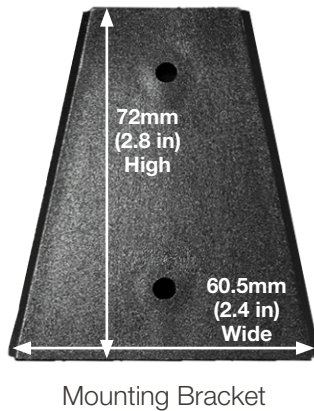

- 1) Choose an installation location that is:
 - Within 1.5m (4.5 ft.) of the product containers.
 - At a reasonable height above the wash tank on the dish machine that allows for easy maintenance access.
 - Away from any direct sources of steam, water spray, and high temperatures.
 - Close enough to the dish machine electrical control panel to allow dispenser wiring without use of an external junction box (not provided) wherever possible.
- 2) Use the mounting bracket to mark the appropriate mounting location and as a hole template to mark the securing holes.
- 3) Wall anchors are provided, please ensure they are appropriate to the wall/surface being mounted to.
- 4) Attach mounting bracket to mounting surface with hardware provided.
- 5) Hang unit on bracket.

2.00 installation (continued)

2.03 Mechanical Installation

Installing the Rinse Injection Fitting

- 1) Install the rinse injection fitting to conform to local plumbing codes.
- 2) The injection fitting is designed to fit global needs. It should thread directly into a 1/8" NPT (North America) or a BSP (Global) female threaded connection. As an alternative to the threaded connection a barb fitting adapter is also included.
- 3) If the machine's rinse plumbing is thin-wall pipe, use a saddle clamp with the 1/8" threaded hole.
- 4) If the machine already has a tapped hole to accommodate the fitting, skip to Step 8
- 5) Choose a location for the rinse injection fitting that is downstream from the vacuum breaker and at the proper height per local plumbing codes. This point is either into the pressurized rinse line or upstream of the booster heater for the rinse water..
- 6) To create the threaded connection at your selected location, drill a 9mm (11/32") hole in the rinse plumbing at the injection location.
- 7) Tap the hole drilled in step 6 with a 1/8" tap (NPT or BSP depending on the region)
- 8) Install the injection fitting. Use thread sealant to ensure a leak-free assembly.

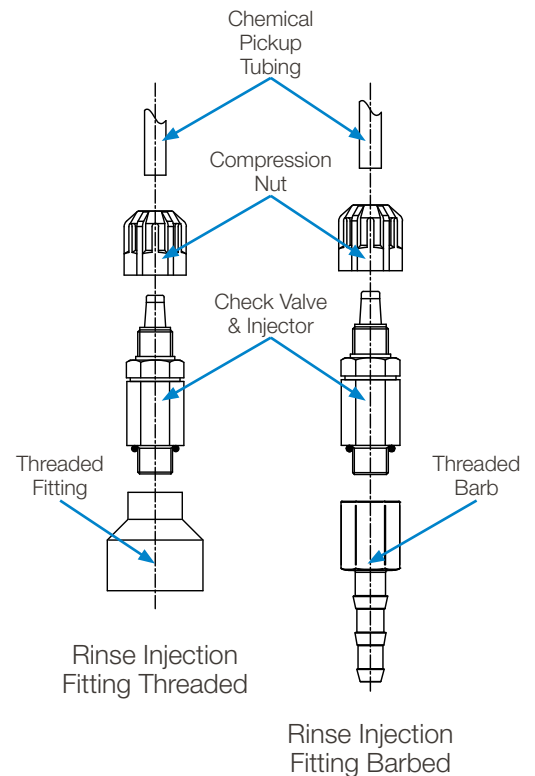

Installing the Detergent Injection Fitting

- 1) When choosing a mounting locating, make sure that the detergent injection fitting will be:
 - Above the water level of the filled wash tank.
 - Discharging detergent directly into the wash tank and not on top of any shelf areas or other obstacles that could prevent detergent from falling directly into the wash tank.
2. Previously punched holes may be suitable but always confirm that the fitting is correctly placed. 10mm (3/8") holes are common in Europe and 22mm (7/8") holes are common in North America. If an appropriate hole is present, go to step 4.
3. If a hole is not available already, drill a 10mm (3/8") hole at the center of your chosen detergent injection location on the dish machine tank.
4. Remove the retaining nut from the supplied detergent injection fitting and gather the gaskets and washers supplied with the unit.
- 5 a. For a 10mm (3/8") hole insert the detergent injection fitting, with a rubber gasket, into the hole you drilled earlier.
b. For a 22mm (7/8") hole insert the detergent injection fitting, with a large rubber gasket backed by a large stainless steel washer.
6. From the inside of the machine install a second rubber washer, stainless backing washer if using a 22mm (7/8") hole, and the retaining nut. Tighten finger-tight, then snug using a wrench.

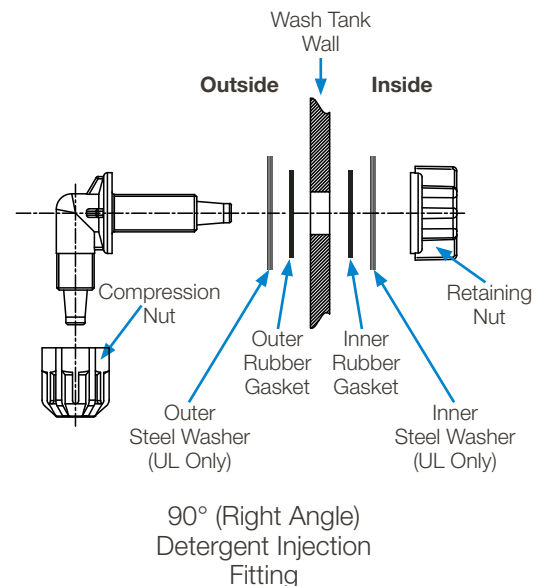

CAUTION! Do not over-tighten the plastic retaining nut.

2.00 installation (continued)

2.03 Mechanical Installation (continued)

Installing the Rinse and Detergent Supply and Discharge Tubes

- 1) Install the included PVC pump supply tube (4mm ID, 6mm OD) into the chemical container using the foot filter with screen and weight to position the tube at the bottom of the container.
- 2) Route the other end of the included PVC pump supply tubes from supply containers to the inlet sides (left) of each respective pump. Slip the tube fully through the compression nut into fitting and tighten.
- 3) Route pump discharge tubes to the outlet sides (right) of each respective pump. Slip the tube fully through compression nut into fitting and tighten.
- 4) Route the other end the pump discharge tube to the appropriate injection fitting (see the injection fitting installation instructions on previous page for more detail). Slip the tube fully through the compression nut onto fitting nipple and tighten.

NOTE: Try to keep both the supply and discharge hoses as straight as possible, avoiding all unnecessary bends.

2.04 Electrical Installation

Installing the Detergent and Rinse Supply Signal Wiring



WARNING! Before performing any work on the CP-500, you must disconnect the power supply voltage of the dish machine.



CAUTION! Verify that electrical grounding is functional and complies with local regulations. Verify that the rated values of the pump are compatible with those of the power supply. Never install the pump directly in parallel with inductive loads (e.g. motors/solenoid valves). If necessary, use an isolating relay.

NOTE: All electrical connections must either be in the dish machine control circuit panel or an external junction box. The dispenser is pre-wired with a multi-conductor electrical cable that may need to be run through a conduit to the location where hard-wired connections are made on the dish machine. If this is the case use approved water tight conduit that meets local and national codes

Depending on the model of the CP-500, there will be one or two pairs of signal/power wires that need to be connected to the dish machine. Using the table below, connect the signal wires to a compatible voltage source.

Wire Color	Circuit Voltage	Function
Brown	90 to 260 VAC at 50/60Hz	AC Power/ Rinse or Detergent Signal to Run Pump
Blue	90 to 260 VAC at 50/60Hz	AC Power/ Rinse or Detergent Signal to Run Pump

Detergent Pumps - Signal Wiring and Programming

Model D1TT - Dish Machine with One Solenoid

Connect the signal cable to the solenoid valve for top up/rinse.

When the signal is activated, the pump will run for the time programmed (0 to 30 seconds) on the upper left top-up dose potentiometer. If the signal stops before the time setting is reached, the pump will stop.

If the signal is still active after 30 seconds, the pump will then run (or continue to run) using the setting (0-240 sec) of the upper right initial charge potentiometer.

Because the pump always runs the Top-up dose and runs it before ...

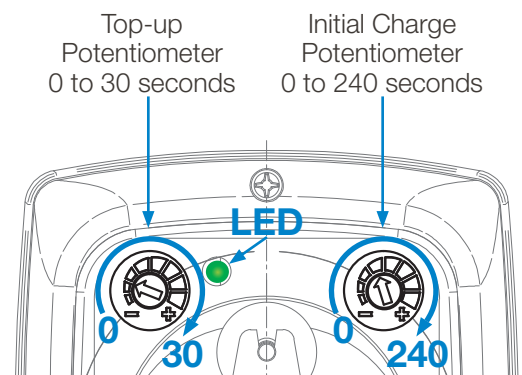

Model D1TT: Top-up and Initial Charge



2.00 installation (continued)

Detergent Pumps - Signal Wiring and Programming (continued)

Model D1TT - Dish Machine with One Solenoid (continued)

... the Initial Charge, you do not set the Initial Charge to the full value you need, but to that full value minus the Top-up dose time. **Example:** If you need an Initial Charge of 70 seconds, and your Top-up dose is set to 15 seconds, then you actually set the Initial Charge potentiometer to 55 seconds. ($70 - 15 = 55$)

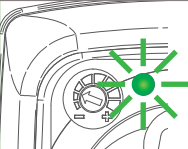
The LED of a model D1TT can display three colors to indicate the various pump operation phases:

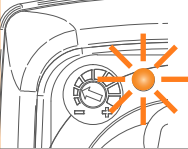
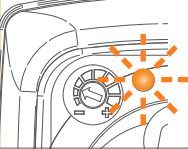
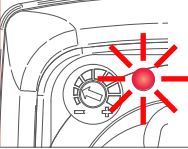
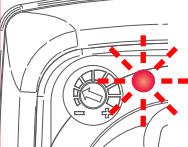
LED Color	Fixed or Flashing	Indication
Green	Fixed	 The only time the LED should display as fixed green would be if the pump has reached the Run / Shut off time and stopped, but the signal remained active.
	Flashing	 Flashing green indicates the pump is dosing. The pump runs at full speed for the set time.
Orange	Fixed	 Fixed orange means the pump is in Priming Mode.
	Flashing	 You should not see the LED flashing orange, unless you are in Custom Programming Mode. (If you do see the LED flashing orange, please contact Technical Support at Hydro Systems Co.)
Red	Fixed	 Fixed red indicates the signal is active, but the pump switch is on the standby/OFF position. (See OFF Alarm in the Flashing text below.)
	Flashing	 Flashing red quickly (1 second on, 1 second off) is an alarm that the pump motor is jammed, or if a level probe is in use, that the chemical supply is low. Flashing red more slowly (2 seconds on, 2 seconds off) is the OFF Alarm, indicating the signal has been active for over 600 seconds, while the pump switch is in the standby/OFF position.



CAUTION! Notice the setting potentiometers are reversed in position from the D1TT to the D2TT.

Model D2TT - Dish Machine with Two Solenoids

Connect the Top-up signal cable to the solenoid valve for top-up/rinse.

When the top-up signal activates the pump will run (at full speed) for the time programmed (0 to 30 seconds) on the upper right top-up dose potentiometer. If the signal stops before the time setting is reached, the pump will stop.

Connect the Fill/Initial Charge signal cable to a signal that is on once per drain / fill cycle, such as the machine's on/off switch.

When the signal activates, the pump runs full speed for the programmed time (0 to 240 seconds) set on the upper left initial charge potentiometer. If the signal stops before the time setting is reached, the pump will stop.

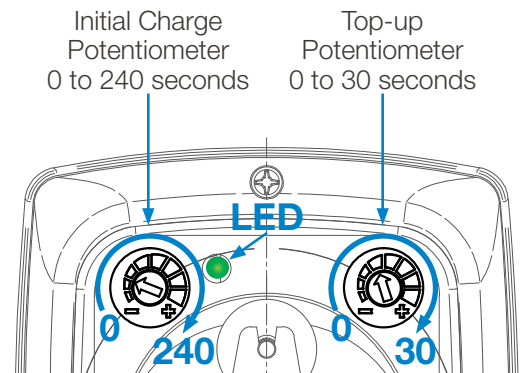

Model D2TT: Initial Charge and Top-up

2.00 installation (continued)

Detergent Pumps - Signal Wiring and Programming (continued)

Model D2TT - Dish Machine with Two Solenoids (continued)

The LED of a model D2TT can display three colors to indicate the various pump operation phases:

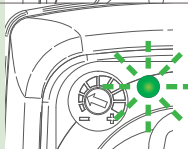
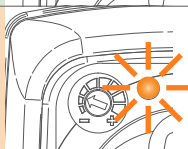
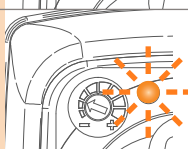
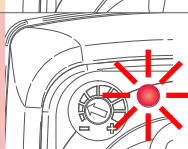
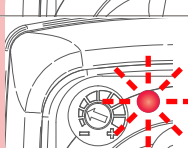
LED Color	Fixed or Flashing	Indication
Green	Fixed	 The only time the LED should display as fixed green would be if the pump has reached the Run / Shut off time for the top-up charge and stopped, but the signal remained active.
	Flashing	 Flashing green indicates the pump is dosing the top-up charge. The pump runs at full speed for the set time.
Orange	Fixed	 You should not see the LED display as fixed orange. (If you do see the LED fixed orange, please contact Technical Support at Hydro Systems Co.)
	Flashing	 Flashing orange quickly (1 second on, 1 second off) is an Alarm, indicating the pump motor is jammed or that the unit is turned off.
Red	Fixed	 The only time the LED should display as fixed red would be if the pump has reached the Run / Shut off time for the initial charge and stopped, but the signal remained active.
	Flashing	 Flashing red indicates the pump is dosing the Initial charge. The pump runs at full speed for the set time.

Rinse Pumps - Signal Wiring and Programming

Model R1ST - Dish Machine with One Solenoid

Connect the signal cable to the solenoid valve for the rinse water.

Speed Setting

The pump runs at the speed set using the left potentiometer.

- Minimum speed (completely turned counterclockwise): 10%
- Maximum speed (completely turned clockwise): 100%

The speed setting is also indicated by flashing the green LED, proportional to the set speed. For example:

10% = 5 seconds ON / 5 seconds OFF = one flash per 10 seconds

50% = 1 second ON / 1 second OFF = five flashes per 10 seconds

100% = 0.5 second ON / 0.5 second OFF = ten flashes per 10 seconds

Run/Shut-off Time Setting

Use the right potentiometer to set the rinse pump run/shut-off time.

Rinse Pump Speed Potentiometer 10% to 100% Run/Shut-off Potentiometer C, or 1-240 seconds

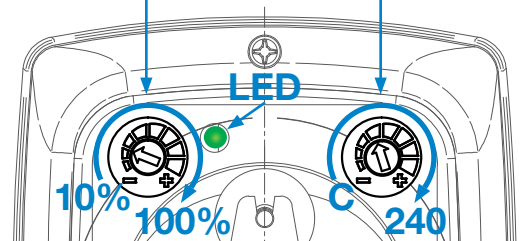

Model R1ST: Speed and Run/Shut-off

(continued)

2.00 installation (continued)

Rinse Pumps - Signal Wiring and Programming (continued)

Model R1ST - Dish Machine with One Solenoid (continued)

Run/Shut-off Time Setting (continued)

If you want the pump to run continuously as long as the rinse signal is active, turn the potentiometer completely counterclockwise.





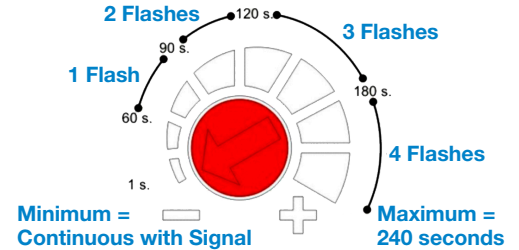

To limit the duration that the pump runs turn the potentiometer clockwise to adjust from 1 to 240 seconds (as shown to the right).

When adjusting the right potentiometer, turn slowly clockwise while watching the LED to help set the correct run/shut-off time. The pump displays four setting positions by flashing the LED:

- When set between 60 and 90 seconds the LED will flash red once.
- When set between 90 and 120 seconds the LED will flash red twice.
- When set between 120 and 180 seconds the LED will flash red 3 times.
- When set between 180 and 240 seconds the LED will flash red 4 times.



The LED of a model R1ST can display three colors to indicate the various pump operation phases:

LED Color	Fixed or Flashing	Indication
Green	Fixed	 The only time the LED should display as fixed green would be if the pump has reached the Run / Shut off time and stopped, but the signal remained active.
	Flashing	 Flashing green indicates the pump is dosing the, and the frequency of the flashing is proportional to the user-defined pump speed.
Orange	Fixed	 Fixed orange means the pump is in Priming Mode.
	Flashing	 You should not see the LED flashing orange, unless you are in Custom Programming Mode (If you do See the LED flashing orange, please contact Technical Support at Hydro Systems Co.)
Red	Fixed	 Fixed red indicates the signal is active, but the pump switch is to the standby/OFF position. (See OFF Alarm in the Flashing text below.)
	Flashing	 Flashing red quickly (1 second on, 1 second off) is an alarm that the pump motor is jammed, or if a level probe is in use, that the chemical supply is low.  Flashing red more slowly (2 seconds on, 2 seconds off) is the OFF Alarm, indicating that the signal has been active for over 600 seconds, while the pump switch is in the standby/OFF position. Additionally, as described above, the LED will flash red is when setting the right potentiometer for shut off time.

2.00 installation (continued)

2.04 Electrical Installation (continued)

Rinse Pumps - Signal Wiring and Programming (continued)

Model R1S - Dish Machine with Two Solenoids

Connect the signal cable to the solenoid valve for the rinse water.

Speed Setting

The pump runs at the speed set using the left potentiometer.

- Minimum speed (completely turned counterclockwise): 10%
- Maximum speed (completely turned clockwise): 100%

The speed setting is also indicated by flashing the green LED, proportional to the set speed. For example:

10% = 5 seconds ON / 5 seconds OFF = one flash per 10 seconds

50% = 1 second ON / 1 second OFF = five flashes per 10 seconds

100% = 0.5 second ON / 0.5 second OFF = ten flashes per 10 second

Rinse Pump Speed
Potentiometer
10% to 100%

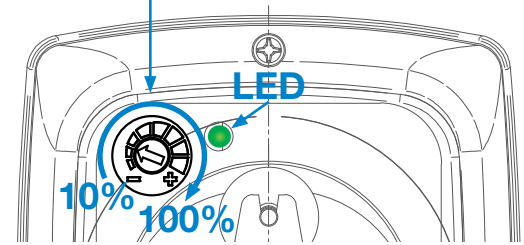

Model R1S: Pump Speed Potentiometer

The LED of a model R1S can display three colors to indicate the various pump operation phases:

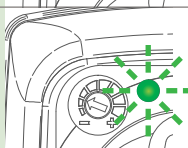
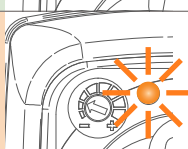
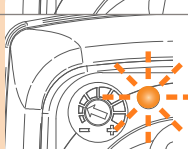
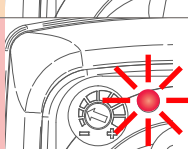
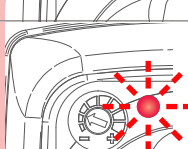
LED Color	Fixed or Flashing	Indication
Green	Fixed	 You should not see the LED display as fixed green. (If you do see the LED display as fixed green, please contact Technical Support at Hydro Systems Co.)
	Flashing	 Flashing green indicates the pump is dosing the, and the frequency of the flashing is proportional to the user-defined pump speed.
Orange	Fixed	 Fixed orange means the pump is in Priming Mode.
	Flashing	 You should not see the LED display as flashing orange. (If you do see the LED flashing orange, please contact Technical Support at Hydro Systems Co.)
Red	Fixed	 Fixed red could indicate the signal is active, but the pump switch is on the standby/OFF position. Fixed red could also indicate that the pump has jammed while the signal is active and the switch is in the ON position
	Flashing	 You should not see the LED display as flashing red. (If you do see the LED flashing red, please contact Technical Support at Hydro Systems Co.)

3.00 operation

3.01 Description of Controls

Overview

The CP-500 makes use of 1 or 2 potentiometers for setting run times and/or speed, a power/prime switch, and a multi-color LED for indicating the dispenser status. The power/prime switch and LED status indications are described below.

Power/Prime Switch Operation

Found on the bottom of pump body, the switch has 3 positions:

- I:** The pump is active (ON). The pump will run normally. If no signal is present, the LED will be off.
- O:** The pump is in stand-by (OFF). The LED will be fixed red.
- II:** The pump is in priming mode. The LED will be fixed orange.

The **II** position of the switch is “momentary”. In priming mode the pump will run at full speed for 60 seconds.

If the **II** position of the switch is pressed again, before the 60 seconds have elapsed, the pump will stop, and the switch will return to the stand-by position.



CP-500 Power / Prime Switch

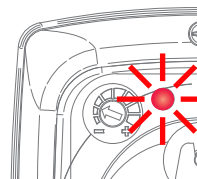

Switch Position **O**
= Stand-by (OFF)
LED is fixed red

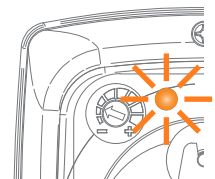

Switch Position **II**
= 60 sec Prime
LED is fixed orange

4.00 service parts

Category	Part No.	Description
Replacement squeeze tubes with compression fittings (packs of 10).		
	HYD10099124	10-Pack Santoprene®
	HYD10099125	10-Pack Silicone
Installation Kits		
Pickup / discharge tubing, foot filter, weight, injection fittings, mounting bracket and hardware		
	HYD10099142	CE Detergent Install Kit
	HYD10099143	CE Rinse Install Kit
	HYD10099144	UL Detergent Install Kit
	HYD10099145	UL Rinse Install Kit

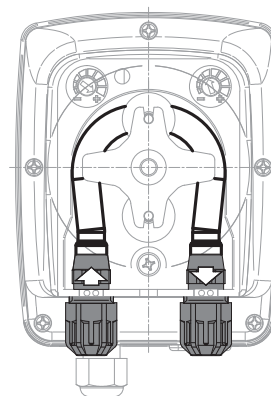

CP-500
Squeeze Tube

Install Kit
(Typical)



5.00 maintenance

5.01 Maintenance (Required)

The CP-500 is designed to require minimal setup and ongoing maintenance. The routine maintenance tasks include:

- Check the pump tube's condition and replace as needed to maintain delivery performance
- Clean the unit cabinet with a damp cloth
- Check the foot strainer and clean it to remove any crystallized product or accumulated dirt.
- Ensure that there are no impurities in the suction and delivery tubes. These may damage the pump tube or cause anomalies in the flow rate.
- Titrate the wash tank solution to verify that unit is holding accurate concentration.

5.02 Pump Tube Replacement



NOTE! When changing pump tubes, be sure to match the correct tube material to the pump. Santoprene® tubes are standard for detergent pumps. Silicone tubes are used for rinse pumps.

Replace pump tubes at regular maintenance intervals, well before the tube fails and ruptures. If the tube does rupture, clean all product from the pump housing with a damp cloth.

- Remove the pump front screw using a 7mm (5/16") hex head driver and detach the pump cover.
- Take out the old tube with compression fittings. Start by rotating the rotor so that the rollers are oriented in an 12/6 o'clock position.
- Starting on the left side, slide the plastic fitting out from the pump. Slowly rotate the pump rotor clockwise while pulling the tube out from the pump race.

Removing the old tube.



Remove the front cover



Align rollers at "12 and 6"

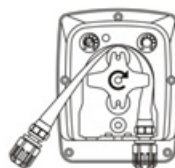

Rotate pump while removing tube

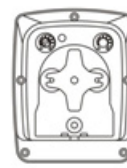

Pump ready for new tube

- Insert the new tube with compression fittings from left side of pump, with pump rollers oriented in an 12/6 o'clock position.
- Slide the compression fitting into place and route the tube vertically into the pump race.

Installing the new tube.

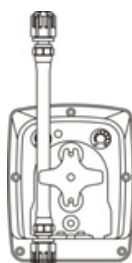

Install compression fitting, route tube up



While turning rotor install tube in race



Attach front cover and tighten screw

- Slowly turn the spinner clockwise, as you position the pump tube into place.
- When finished reinstall the pump cover and front screw.

6.00 troubleshooting

6.01 Troubleshooting Table

Problem	Cause	Solution
1. Dead unit - No LEDs illuminated	a. No incoming main electrical power	<ul style="list-style-type: none"> • Check wiring from dish machine. • Check for power at dish machine connection.
	b. Bad PC board	<ul style="list-style-type: none"> • If board has failed, replace the CP-500 unit.
2. No chemical dispensing.	a. No signal received	<ul style="list-style-type: none"> • Check signal wiring to dish machine. • Check that dish machine is sending a signal.
	b. Unit is not primed	<ul style="list-style-type: none"> • Prime the unit by using the Priming position of the power switch, or by activating the appropriate signal to run the pump.
	c. Power switch is in the wrong position	<ul style="list-style-type: none"> • Confirm the power switch is in the I (ON) position
	d. Pump tube is damaged or worn	<ul style="list-style-type: none"> • Replace pump tube as needed.
	e. Foot filter is clogged, or incorrectly positioned	<ul style="list-style-type: none"> • Remove the foot filter and clean as needed. • Check to insure the weight is installed correctly and the filter is positioned at the bottom of the container.
	f. Clogged delivery tube or bad connection of tubing or fitting	<ul style="list-style-type: none"> • Check and tighten all connectors. • Replace tubing and fittings as needed.
3. Excessive or inadequate chemical consumption	a. Incorrect pump wiring	<ul style="list-style-type: none"> • Check wiring from dish machine.
	b. Clogged delivery tube or bad connection of tubing or fitting	<ul style="list-style-type: none"> • Check and tighten all connectors. • Replace tubing and fittings as needed.
	c. Worn pump tube	<ul style="list-style-type: none"> • Replace pump tube as needed.

7.00 Specifications

7.01 Specifications

(Specifications subject to change without notice.)

Category	Specification
Size	5.0 in (128 mm) High x 3.6 in (91 mm) Wide x 4.1 in (104 mm) Depth
Weight	2.4 lb (1.1 kg)
Power Rating	90 to 260 VAC at 50/60 Hz up to 50 mA
Flow Rate (at full speed)	Detergent Pumps: 100 ml/min (3.4 oz/min) Rinse Pumps: 17 ml/min (0.57 oz/min)
Duty Cycle	20 hours on, 4 hours off
Regulatory Approvals	
CE	89/336/CEE 72/23/CEE
UL CSA	778:ed6-2016 C22.2 No.108:14
	Regarding "Electromagnetic Compatibility" and the subsequent modifications 92/31/CEE, 93/68/CEE and 93/97/CEE Regarding "Low Voltages", and the subsequent modification 93/68/CEE, 2002/95/CE, 2002/96/CE and 2003/108/CE "RoHs and WEEE Directive"
	Standard for Motor-Operated Water Pumps Liquid Pumps
Wetted Parts: Material of Construction	
Chemical Pickup "Foot Filter"	Polypropylene
Chemical Pickup Tubing	Santoprene® (Detergent and Rinse models)
Pump Squeeze Tube	Santoprene® (Silicone is available on request.)
Pump Discharge Tubing	PVC for Detergent models / Polyethylene for Rinse models
Injection Fitting(s)	Polypropylene
Environmental Specifications	
Intrusion Protection (IP) Rating	IP Rating: 55
Temperature	10° to 49° C (50° to 120° F) maximum
Humidity	95% relative humidity, maximum
Indoor Installation	Approved for indoor use only. Must not be installed outdoors.

8.00 warranty

8.01 Limited Warranty

Seller warrants solely to **Buyer** the Products will be free from defects in material and workmanship under normal use and service for a period of one year from the date of completion of manufacture. This limited warranty does not apply to (a) hoses; (b) and products that have a normal life shorter than one year; or (c) failure in performance or damage caused by chemicals, abrasive materials, corrosion, lightning, improper voltage supply, physical abuse, mishandling or misapplication. In the event the Products are altered or repaired by **Buyer** without **Seller's** prior written approval, all warranties will be void.

No other warranty, oral, express or implied, including any warranty of merchantability or fitness for any particular purpose, is made for these products, and all other warranties are hereby expressly excluded.

Seller's sole obligation under this warranty will be, at **Seller's** option, to repair or replace F.O.B. **Seller's** facility in Cincinnati, Ohio any Products found to be other than as warranted.

8.02 Limitation of Liability

Seller's warranty obligations and **Buyer's** remedies are solely and exclusively as stated herein. **Seller** shall have no other liability, direct or indirect, of any kind, including liability for special, incidental, or consequential damages or for any other claims for damage or loss resulting from any cause whatsoever, whether based on negligence, strict liability, breach of contract or breach of warranty.



Hydro Systems
3798 Round Bottom Road
Cincinnati, OH 45244

Phone 513.271.8800
Toll Free 800.543.7184
Fax 513.271.0160
Web hydrosystemsco.com